



BALL VALVE DN50 PN40

20-0000072
440194

Straight type

DESCRIPTION: Three piece, full bore, Stainless Steel body ball valve with Stainless Steel ball and PTFE seat. Raised face flanges.

STANDARD & DESIGN:

Face To Face Standard	EN 558, series 1
Remark	Connection: PN40
Throughput Direction	Straight
Execution	Full Bore
End Type	Flanged
Standard	DIN
Material Seat	PTFE
Material Body	Stainless Steel, 316
Sub Category	BALL
Item Number	20-0000072
Category	Valve

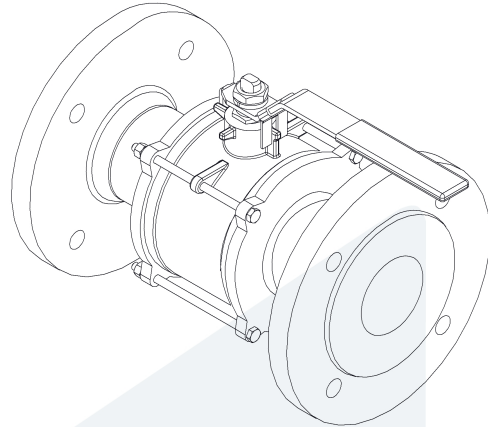

No	Part	Material	Code	Application
6	Handle	Stainless Steel, Plastic Cover	AISI 430	Air
1	Body	Stainless Steel	ASTM A351-CF8M	Boiler feedwater
2	Cap	Stainless Steel	ASTM A351-CF8M	Cargo oil
3	Ball	Stainless Steel	ASTM A351-CF8M	Condensate
4	Seat	PTFE		Corrosive fluids
5	Stem	Stainless Steel	AISI 316	Flammable hydraulic oil
				Fuel oil
				Gas
				Lubricating oil
				Non-flammable hydraulic fluid
				Sea water
				Water

DN	Pressure Rating Id	nxdd	Hcd	Ø D	L	Kg	L1	H
50	40	4x18	125	165	230	11.7	185	117

