



BALL VALVE DN65 PN16

Straight type - with direct mounting pad - fire safe

20-00000964
445192

DESCRIPTION: Two piece, full bore, Stainless Steel body ball valve with Stainless Steel ball and SS+PTFE seat. Raised face flanges. With direct mounting pad. Fire safe version.

STANDARD & DESIGN:

End Standard	DIN 2633
Face To Face Standard	EN 558, series 14
Inspection Standard	EN 12266
Remark	Connection: PN16
Top Flange Standard	ISO 5211 - F07/F10
Throughput Direction	Straight
Execution	Full Bore
Variant	Fire Safe
End Type	Flanged
Design Code	ASME B16.34
Standard	DIN
Material Seat	SS+PTFE
Material Body	Stainless Steel, 316
Sub Category	BALL
Item Number	20-00000964
Category	Valve

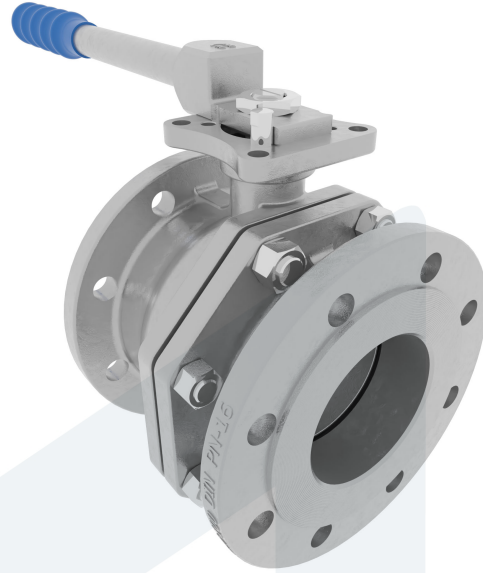

No	Part	Material	Code	Application
1	Body	Stainless Steel	ASTM A351-CF8M	Air
2	Cap	Stainless Steel	ASTM A351-CF8M	Boiler feedwater
3	Ball	Stainless Steel	ASTM A351-CF8M	Cargo oil
4	Seat	SS+PTFE		Condensate
5	Stem	Stainless Steel	AISI 316	Corrosive fluids
6	Handle	Stainless Steel, Plastic Cover	AISI 430	Flammable hydraulic oil
				Fuel oil
				Gas
				Lubricating oil
				Non-flammable hydraulic fluid
				Sea water
				Water

DN	Pressure Rating Id	nxdd	Hcd	Ø D	L	Kg	L1	H	H1	H2	S
65	16	4x18	145	185	170	15	277.5	155,5	118.5	137	17

