



SWING CHECK VALVE DN25 PN16

60-00000031
304622

DESCRIPTION: RG5 body swing check valve with metal sealing.
Screwed cover. Flat face flanges.

STANDARD & DESIGN:

End Standard	EN 1092-3
Remark	Connection: PN16
Min temperature	-10°C
Max temperature	+180°C
Throughput Direction	Straight
End Type	Flanged
Standard	DIN
Material Disc	Brass
Material Body	Bronze
Sub Category	CHECK
Item Number	60-00000031
Category	Valve

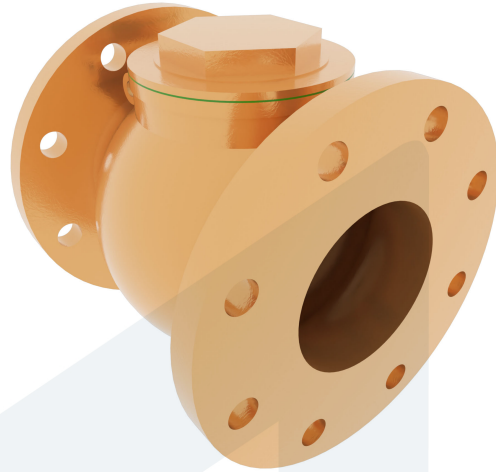

No	Part	Material	Code	Application
1	Body	Bronze	CC 491K	Boiler feedwater
2	Cap	Brass	CW 614N	Cargo oil
3	Disc	Brass	CW 614N	Condensate
4	Swing arm	Brass	CW 614N	Flammable hydraulic oil
5	Pivot	Brass	CW 614N	Fuel oil
6	Gasket	Fiber		Lubricating oil
7	Disc nut	Brass	CW 614N	Sea water
				Water

DN	Pressure Rating Id	nxdd	Hcd	Ø D	L	Kg
25	16	4x14	85	115	99	2.5

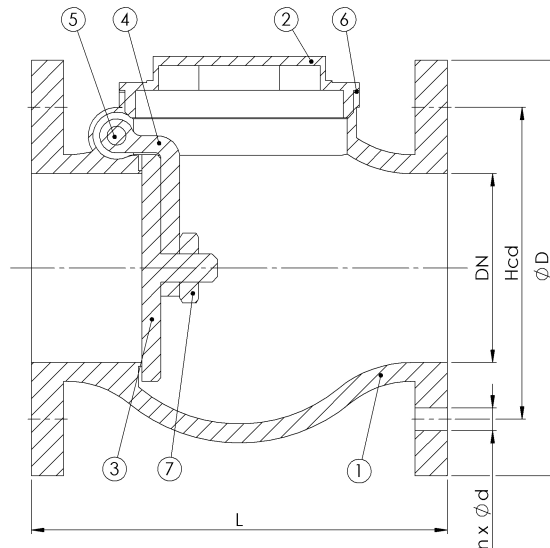
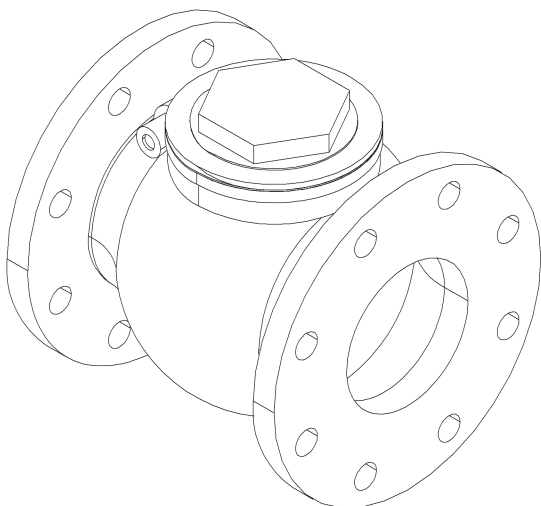

2023-01-07