



GATE VALVE DN20 PN16

130-0000109
400822

DESCRIPTION: RG5 body gate valve, RG5 wedge. Non rising stem, screwed bonnet. Flat face flanges.

STANDARD & DESIGN:

End Standard	EN 1092-3
Inspection Standard	EN 12266
Remark	Connection: PN16
Min temperature	0°C
Max temperature	+95°C
Throughput Direction	Straight
End Type	Flanged
Standard	DIN
Material Disc	Bronze
Material Body	Bronze
Sub Category	GATE
Item Number	130-0000109
Category	Valve

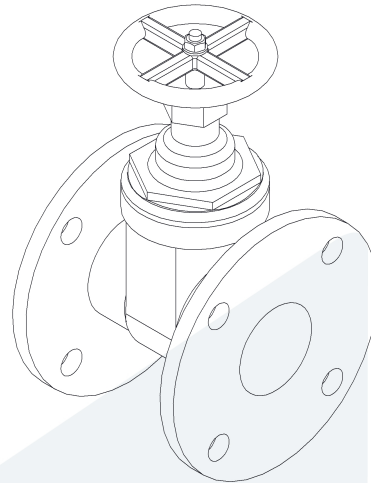

No	Part	Material	Code	Application
1	Body	Bronze	CC 491K	Air
2	Bonnet	Brass	CW 614N	Boiler feedwater
3	Wedge	Bronze	CC 491K	Cargo oil
4	Stem	Brass	CW 614N	Condensate
5	Bonnet Gasket	Heat Resistant Fiber		Flammable hydraulic oil
6	Packing	Heat Resistant Fiber	AF/15MA	Fuel oil
7	Gland	Brass	CW 614N	Gas
8	Gland nut	Brass	CW 614N	Lubricating oil
9	Stem nut	Brass	CW 614N	Non-flammable hydraulic fluid
10	Handwheel	Steel		Sea water
				Steam
				Thermal oil
				Water

DN	Pressure Rating Id	nxdd	Hcd	Ø D	L	Kg	H	Ø M
20	16	4x14	75	105	80	1.8	103	60

