



GLOBE VALVE DN20 PN16

150-00000757
467052

Straight type - SDSL

DESCRIPTION: Straight type, Cast Iron body, metal seated globe valve with rising stem and bolted bonnet. Raised face flanges.

STANDARD & DESIGN:

End Standard	EN 1092-2
Face To Face Standard	EN 558, series 1
Remark	Connection: PN16
Throughput Direction	Straight
Variant	SDSL
End Type	Flanged
Design Code	DIN 86251
Standard	DIN
Material Seat	Stainless Steel, 304
Material Disc	Stainless Steel, 420
Material Body	Cast Iron
Sub Category	GLOBE
Item Number	150-00000757
Category	Valve



No	Part	Material	Code	Application
1	Body	Cast Iron	GG25	Cargo oil
2	Bonnet	Cast Iron	GG25	Flammable hydraulic oil
3	Seat	Stainless Steel	1.4301	Fuel oil
4	Disc	Stainless Steel	1.4021	Lubricating oil
5	Stem	Stainless Steel	1.4021	Sea water
6	Gland packing	Graphite		Water
7	Gasket	Graphite		
8	Handwheel	Cast Iron	GG25	

DN	Pressure Rating Id	nxdd	Hcd	Ø D	L	Kg	H	Ø M
20	16	4x14	75	105	150	4	165	120

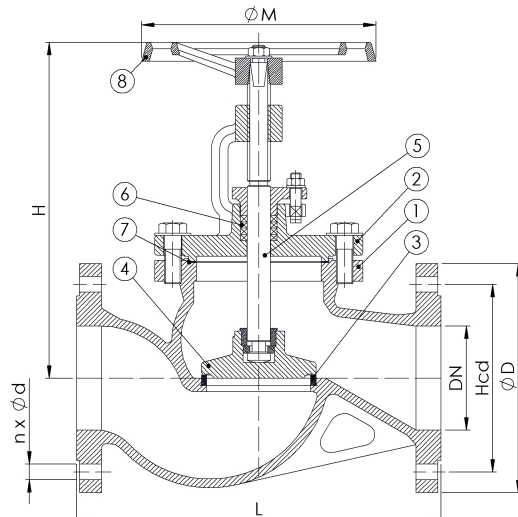

2023-01-25