



GLOBE VALVE DN32 PN16

150-00000783
467052

Straight type - SDNR with spring

DESCRIPTION: Straight type, Cast Iron body, metal seated globe valve with rising stem and bolted bonnet. Raised face flanges.

STANDARD & DESIGN:

End Standard	EN 1092-2
Face To Face Standard	EN 558, series 1
Remark	Connection: PN16
Throughput Direction	Straight
Variant	SDNR with spring
End Type	Flanged
Design Code	DIN 86252
Standard	DIN
Material Seat	Bronze
Material Disc	Bronze
Material Body	Cast Iron
Sub Category	GLOBE
Item Number	150-00000783
Category	Valve



No	Part	Material	Code	Application
1	Body	Cast Iron	GG25	Cargo oil
2	Bonnet	Cast Iron	GG25	Flammable hydraulic oil
3	Seat	Bronze	RG5	Fuel oil
4	Disc	Bronze	RG5	Lubricating oil
5	Stem	Special Brass	Som59	Sea water
6	Gland packing	Graphite		Water
7	Gasket	Graphite		
8	Handwheel	Cast Iron	GG25	

DN	Pressure Rating Id	nxdd	Hcd	Ø D	L	Kg	H	Ø M
32	16	4x19	100	140	180	7	180	140

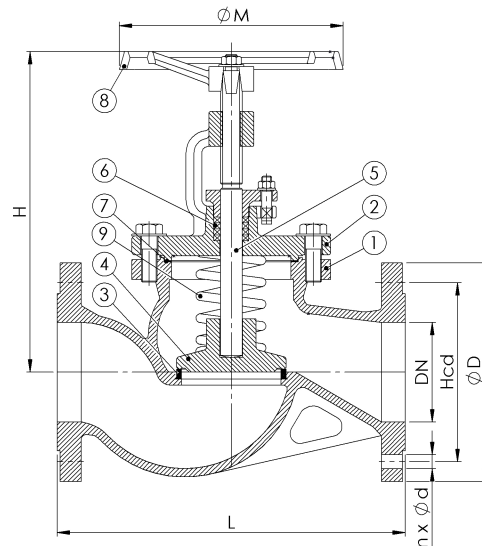

2023-01-25